



DigiWx

HEMS Weather Summit

Boulder, Colorado

March 22, 2006

Belfort Instrument: 125 Years of Excellence



The Wright Brothers relied on us.

December 17, 1903—Weather Station #6, Kitty Hawk, NC—Wind NE at 21 mph

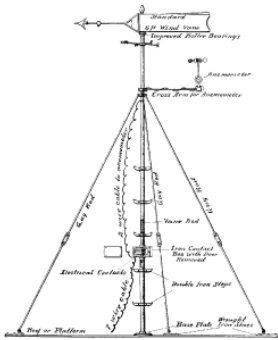

Belfort/Friez U.S. Weather Bureau Station, circa 1897-1913



Belfort Instrument: 125 Years of Excellence

Business: Leading provider of environmental measurement solutions to the meteorological, highway safety, and optical sensor markets

Headquarters: Baltimore, MD

Employees: 43

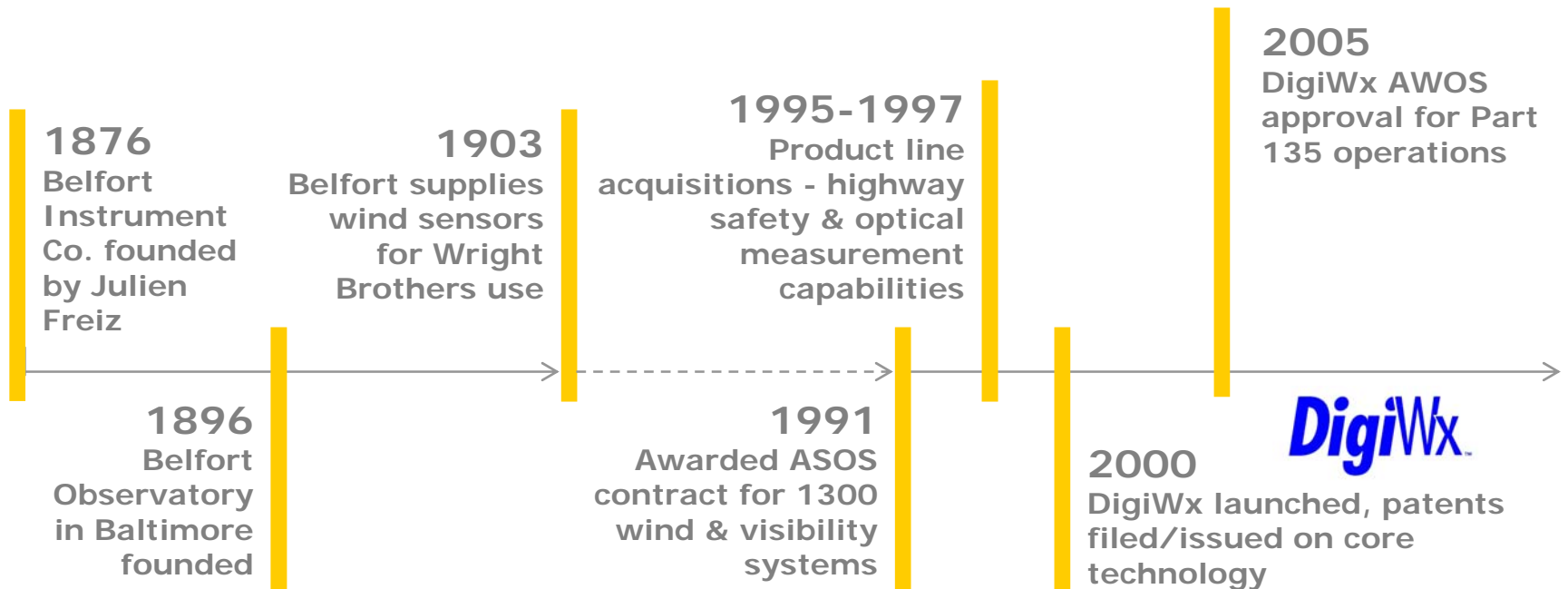

Very few Heliports are equipped with traditional AWOS/ASOS equipment because...

- FAA regulatory hurdles;
- FCC regulatory hurdles;
- Large acquisition and support expenses;
- One-size-fits-all solutions dominate;

...the solution lies somewhere between a wind sock and traditional AWOS III...

Design a DigiWx that supports IFR operations that has...

- Lowest cost for acquisition, siting and installation;
- Remote support package that significantly reduces maintenance costs;
- Automated Unicom or discreet frequency for fast commissioning;
- Internet based graphical user interface;
- Modular architecture/easy to upgrade



DigiWx System Data Distribution Options

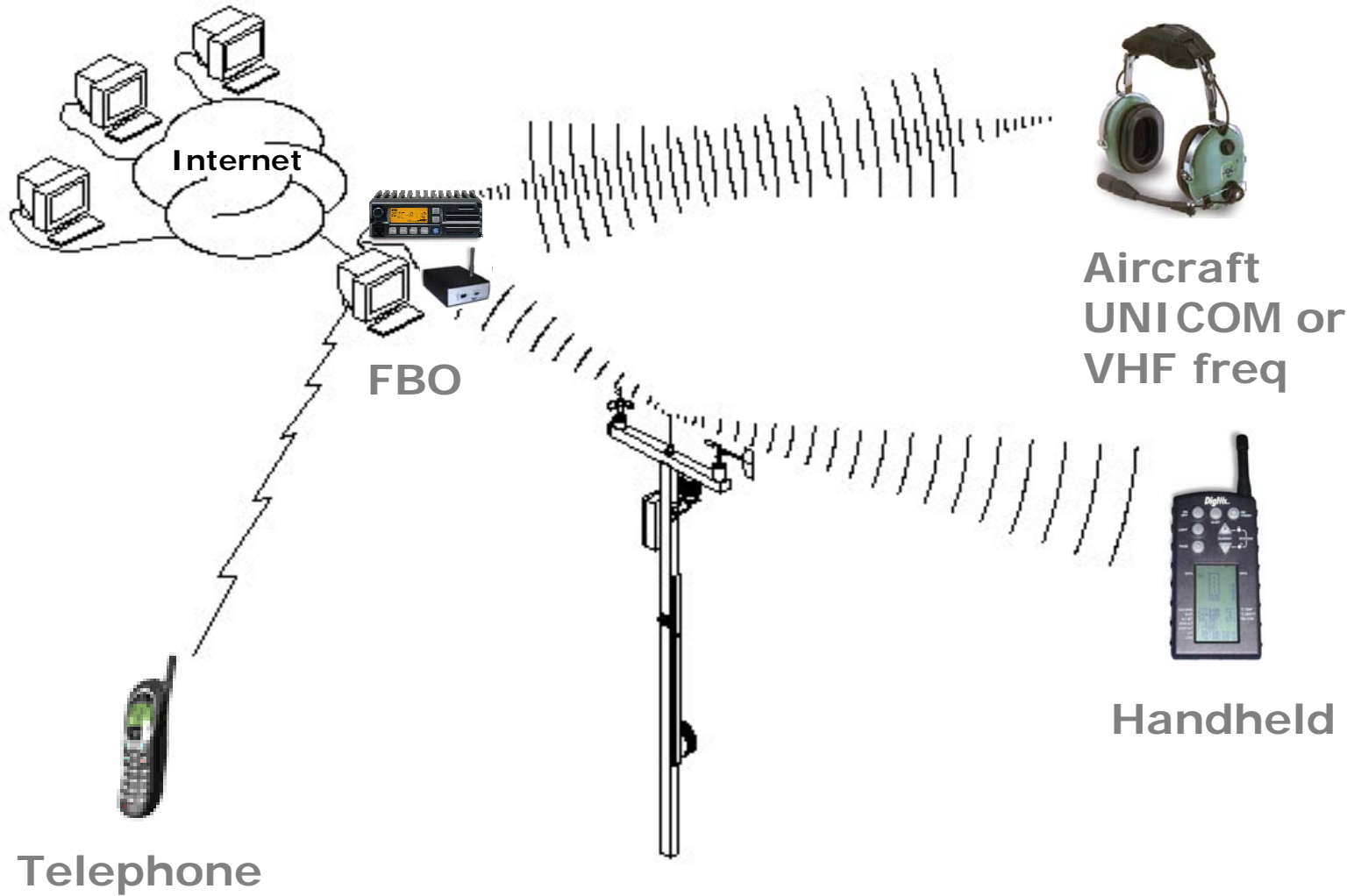

- Displays live info transmitted from weather station
- Historical files stored on PC with option for off-site backup
- Automated alerts from programmable event manager
- Internet & telephone dial in options

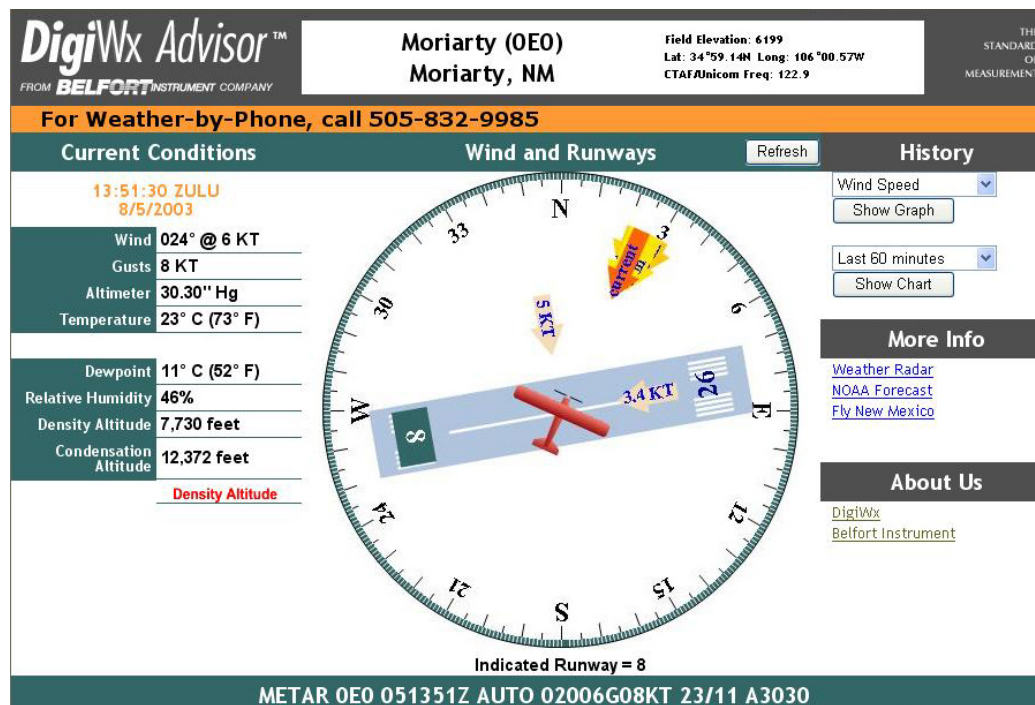

New Capability – DigiWx Web Cam

DigiWx Web Cam – new enhancement to DigiWx Advisor graphical display software provides live image of local heliport environment available on DigiWx website capable of:

- Remote access to current heliport visual conditions
- Effective proxy for prevailing visibility
- selectable time frame for auto refresh of image
- Multiple web cams can be positioned for enhanced security

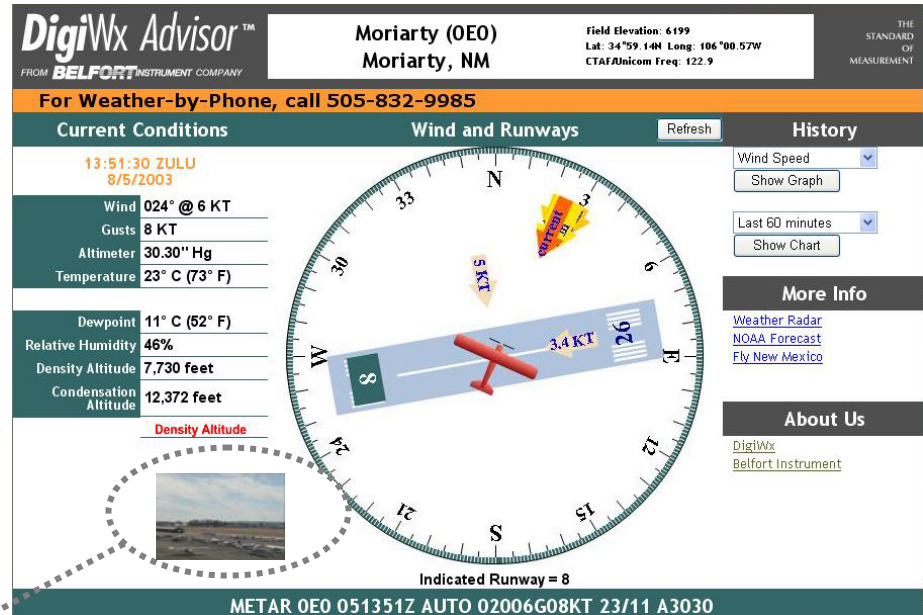

Click "thumbnail" image on web page to enlarge live image

- Training of local technician(s) completed at time of installation;
- Remote technical support via phone/email
- Automated fault notification
- Calibration standard for altimeter setting
- Custom designed solutions for states with multiple installations resulting in minimal post sale expense



DigiWx AWOS Installations

- Altoona Hospital, PA
- AtlantiCare Regional, NJ
- Green Bay County Rescue, WI
- Robert Packer Hospital, PA
- Dominica Hospital, CA
- Maryland Shock Trauma, MD
- Butte, MT
- Anaconda, MT
- Coral Creek, FL
- Creech AFB, NV
- Greenville, IL
- Lake in the Hills, IL
- Eureka, MT
- Ocean City, NJ

Just to name a few





The Wright Brothers relied on us.

December 17, 1903—Weather Station #6, Kitty Hawk, NC—Wind NE at 21 mph

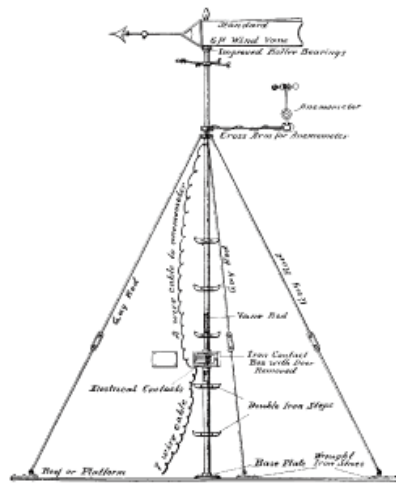

Belfort/Friez U.S. Weather Bureau Station, circa 1897-1913

belfortinstrument.com

Today you can, too!

Wireless—Internet—PDA—Mobile—Voice Recognition

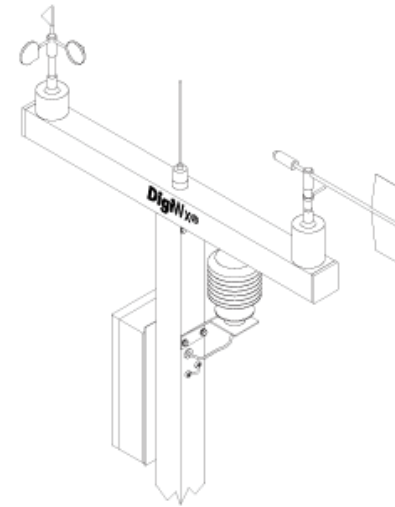

DigiWx® Automated Digital Weather System, circa 2002

Belfort Instrument Company

727 South Wolfe Street

Baltimore, Maryland 21231

410 342-2626

410 342-7028 Fax

www.digiwx.com

rpetragnani@belfortinstrument.com